

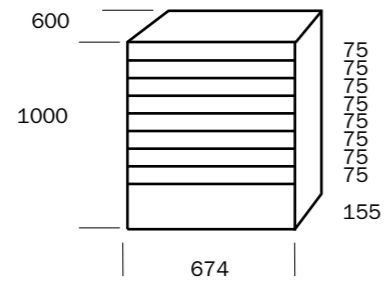

Cod. **0100290001**

**Modulo a 9 cassetti**

Module 9 tiroirs  
Cabinet 9 drawers  
Dulap cu 9 sertare  
Módulo 9 cajones



Kg 68



Cod. **0100290002**

**Modulo a 9 cassetti**

Module 9 tiroirs  
Cabinet 9 drawers  
Dulap cu 9 sertare  
Módulo 9 cajones

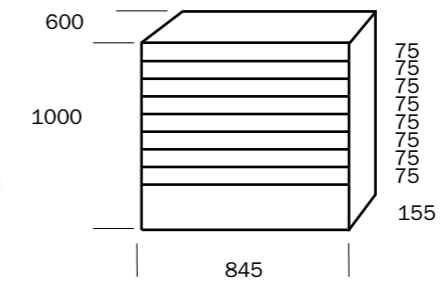

Kg 81



Cod. **0100290003**

**Modulo con anta battente**

Module avec porte battante  
Cabinet with hinged door  
Dulap cu usi culisante  
Módulo con puerta con bisagras

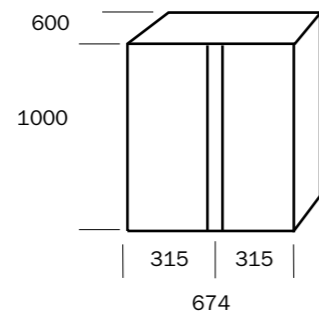

Kg 38



Cod. **0100290004**

**Modulo con anta battente**

Module avec porte battante  
Cabinet with hinged door  
Dulap cu usi culisante  
Módulo con puerta con bisagras

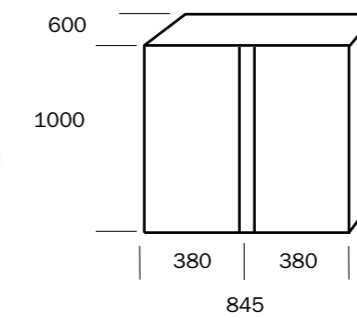

Kg 46



Cod. **0100290005**

**Modulo a 4 cassetti a scomparsa**

Module 4 tiroirs avec porte escamotable  
Cabinet 4 drawers and retractable door  
Dulap cu 4 sertare si usa  
Módulo 4 cajones y puerta retractable

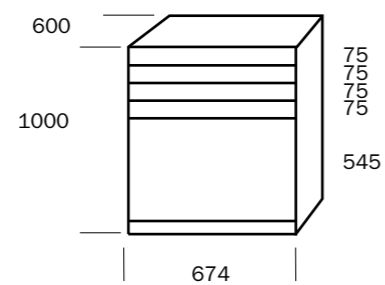

Kg 50



Cod. **0100290006**

**Modulo a 4 cassetti a scomparsa**

Module 4 tiroirs avec porte escamotable  
Cabinet 4 drawers and retractable door  
Dulap cu 4 sertare si usa  
Módulo 4 cajones y puerta retractable

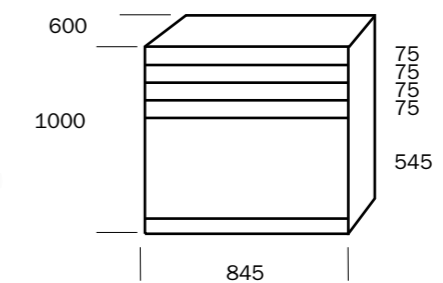

Kg 63



Cod. **0100290027**

### Modulo angolare

Module angulaire  
Corner module  
Dulap pecolt  
Modulo angular

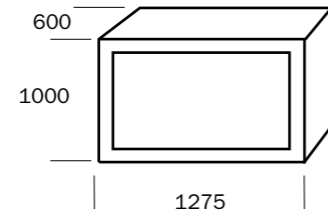

Kg 45



Cod. **0100290028**

### Kit pensile angolare

Kit module suspendu angulaire  
Corner shelf module kit  
Kit raft suspendate pe colt  
Kit modulo pensil angular

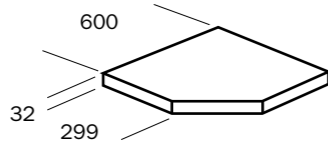

Kg 3 cad.



Cod. **0100290008**

### Modulo armadio 2000

Module armoire avec porte battante 2000  
Cabinet wardrobe with hinged doors 2000  
Dulap cu usa culisanta H 2000  
Gabinete forma H 2000

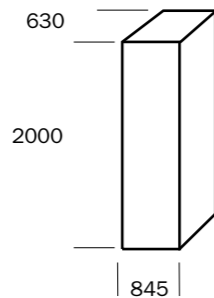

Kg 70

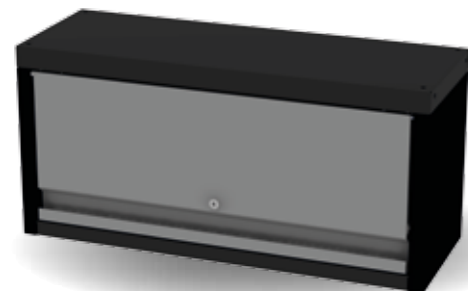

### Modulo armadio pensile

Module unité murale  
Cabinet wall unit  
Dulap suspendat pe perete  
Módulo incorporado en la unidad de pared

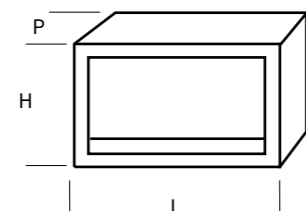

| Cod.              | H   | L   | P   | Kg |
|-------------------|-----|-----|-----|----|
| <b>0100290009</b> | 400 | 674 | 300 | 11 |
| <b>0100290010</b> | 400 | 845 | 300 | 14 |

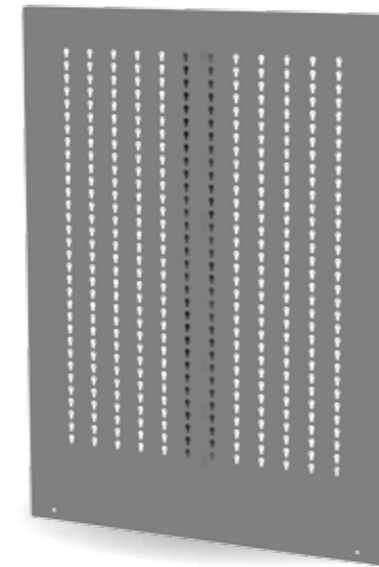

### Pannelo portautensili

Panneaux porte-outils  
Steel plate tools-stand panels  
Panou perforat pentru scule  
Panel perforado para herramientas

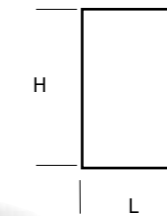

| Cod.              | H    | L   | Kg  |
|-------------------|------|-----|-----|
| <b>0100290026</b> | 1040 | 440 | 5,5 |
| <b>0100290011</b> | 1040 | 613 | 7   |
| <b>0100290012</b> | 1040 | 794 | 8,5 |



### Asta per pannelo portautensili

Tige pour panneau porte-outils  
Bar for tools panel  
Suport pentru panoul de scule  
Asta por panel portaherramientas

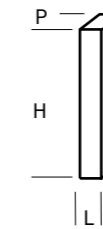

| Cod.              | H    | L  | P  | Kg  |
|-------------------|------|----|----|-----|
| <b>0100290014</b> | 2000 | 30 | 30 | 2,5 |
| <b>0100290013</b> | 2000 | 60 | 30 | 4,5 |



### Piana in faggio

Plateau hêtre  
Beech-wooden board  
Blat de fag  
Plancha de haya

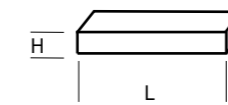

| Cod.              | H  | L    | P   | Kg   |
|-------------------|----|------|-----|------|
| <b>0100290015</b> | 40 | 674  | 500 | 9,25 |
| <b>0100290016</b> | 40 | 845  | 500 | 11,6 |
| <b>0100290030</b> | 40 | 1175 | 500 | 16,1 |
| <b>0100290017</b> | 40 | 1348 | 500 | 18,5 |
| <b>0100290034</b> | 40 | 1529 | 500 | 23   |
| <b>0100290018</b> | 40 | 1690 | 500 | 23,2 |
| <b>0100290019</b> | 40 | 2193 | 500 | 30   |
| <b>0100290032</b> | 40 | 2022 | 500 | 30   |
| <b>0100290033</b> | 40 | 2364 | 500 | 35   |



### Piana in acciaio inox satinato

Plateau en acier inoxydable brossé  
Brushed stainless steel board  
Blat de otel inox satinat  
Plancha de acero inoxidable satinado

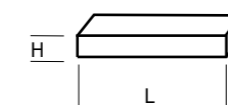

| Cod.              | H  | L    | P   | Kg   |
|-------------------|----|------|-----|------|
| <b>0100290025</b> | 40 | 674  | 500 | 12   |
| <b>0100290020</b> | 40 | 845  | 500 | 15   |
| <b>0100290031</b> | 40 | 1175 | 500 | 22   |
| <b>0100290021</b> | 40 | 1348 | 500 | 24   |
| <b>0100290037</b> | 40 | 1529 | 500 | 30   |
| <b>0100290022</b> | 40 | 1690 | 500 | 30,5 |
| <b>0100290023</b> | 40 | 2193 | 500 | 40   |
| <b>0100290035</b> | 40 | 2022 | 500 | 39   |
| <b>0100290036</b> | 40 | 2364 | 500 | 45   |

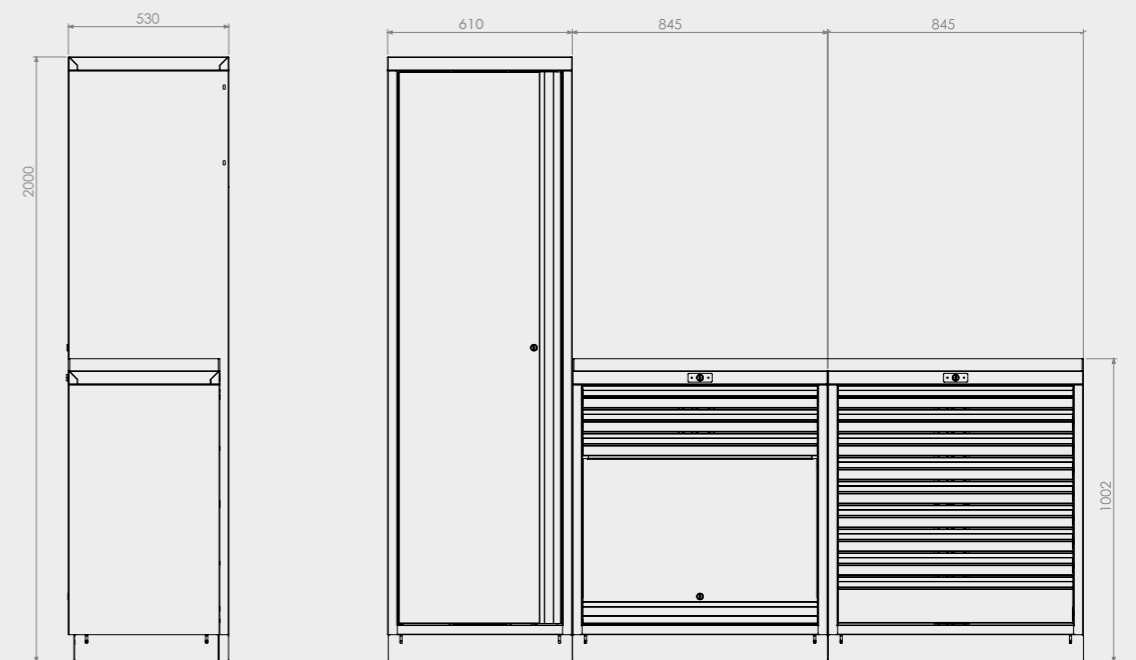
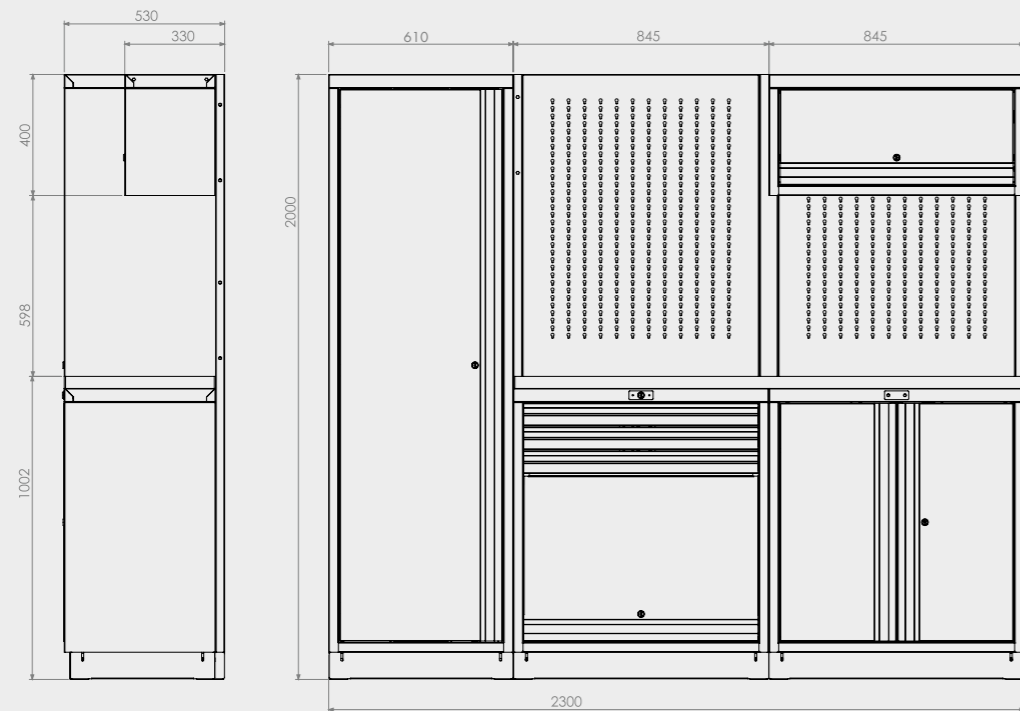

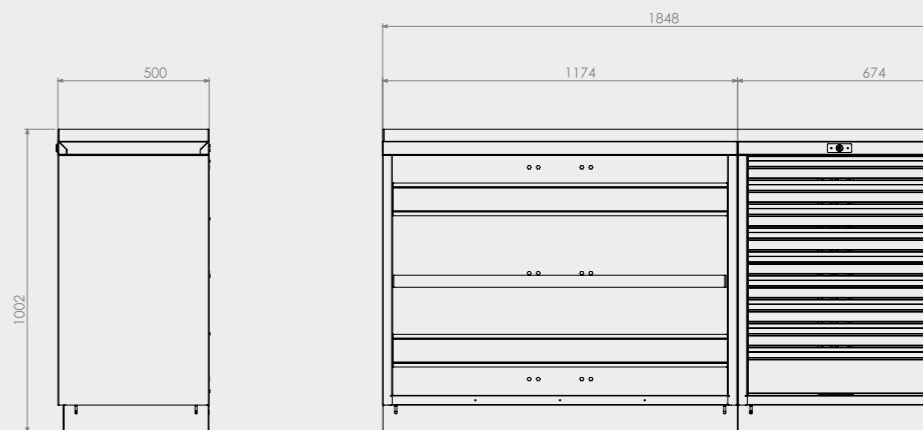
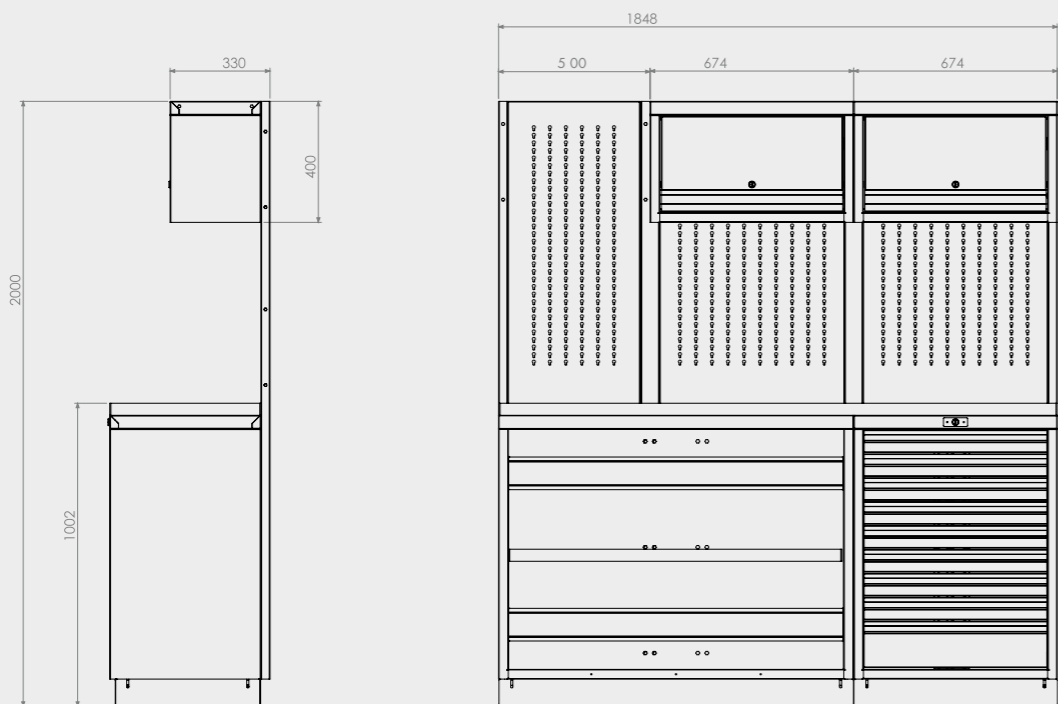

MP3 è un pannello blu 1000x500 confezionato insieme ad una serie di accessori in plastica. L'imballo è realizzato in termoretraibile e foglio pubblicitario.

MP3 est un panneau bleu 1000 x 500 conditionné avec une série d'accessoires en plastique. L'emballage est fait en film thermorétractile et feuille publicitaire.

MP3 ist eine blaue Lochwand 1000x500 mit Zubehörteilen aus Plastik. Die Lochwand ist mit einem Werbeposter in einer angeschweissten Plastikfolie verpackt.

MP3 panel is a blue panel 1000x500 packed up together with a series of plastic accessories. The package is made of thermoretractable film and advertising sheet.

MP3 es un tablero azul 1000x500 confeccionado junto con una serie de accesorios de plástico. El embalaje ha sido realizado con material termo-retráctil y hoja publicitaria.

Panou de 1000x500 de culoare albastra; Pachetul contine un kit de 40 de carlige din plastic pentru scule diverse.

**Art. Master Profi 3**

1 prof. 10/10, 1.000 x 500 mm.  
10 - Art. B01, 6 - Art. B02, 6 - Art. B03,  
4 - Art. B04, 4 - Art. B05,  
6 - Art. B06, 4 - Art. B10, tot. 40 Art. 4 Plugs



Cod. 010010002

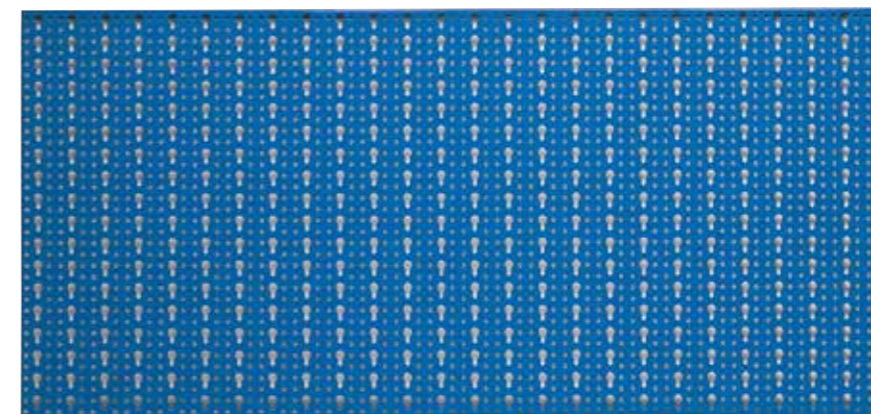
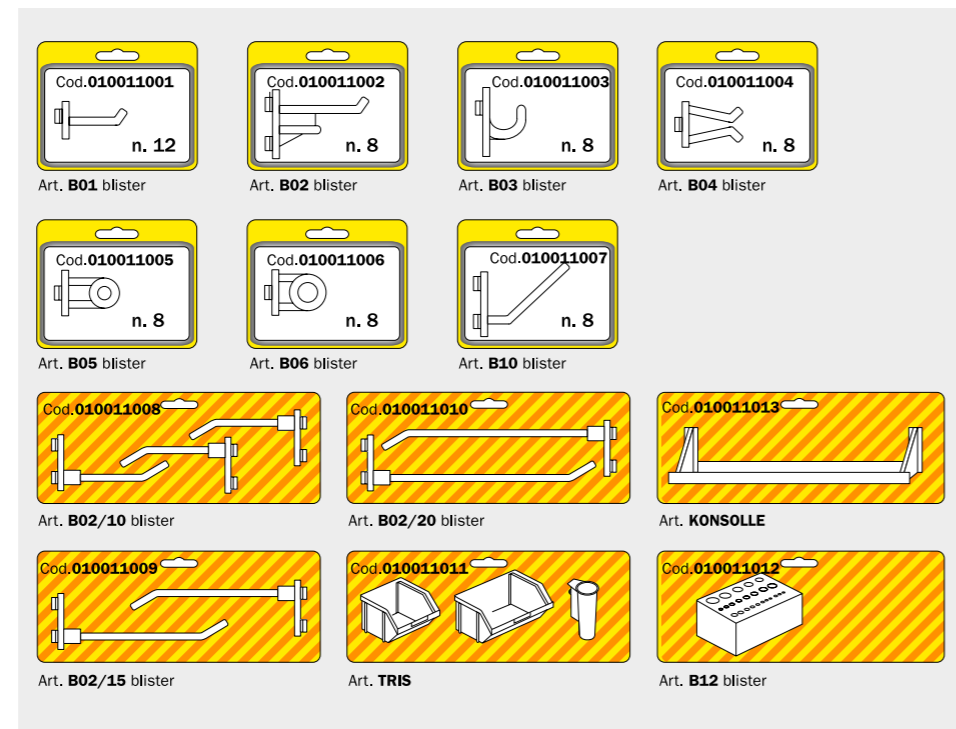

Avorio/Sable  
Ivory/Beige  
Marfil/RO

Art. Profi 500x1000 Cod. 010001002  
10/10 (box n.6)

- Pannelli portautensili in lamiera d'acciaio verniciati con polveri epossidiche.
- Vasta gamma di accessori in plastica (Nylon e ABS)
- Panneaux porte-outils en tôle peinte avec poudre époxyde. Grande gamme d'accessoires plastiques. (Nylon et ABS)
- Steel plate tools-stand panels, painted with epoxy powder. Wide range of plastic accessories. (Nylon and ABS)
- Werkzeugwände aus Stahlblech, pulverbeschichtet. Grosse Auswahl an Zubehörteilen aus Plastik. (Nylon und ABS)
- Panel perforado para herramientas en chapa de acero lacada con pintura epoxi. Amplia gama de accesorios y soportes de plástico (Nylon y ABS)
- panouri perforate pentru scule de diferite dimensiuni si culori din tabla vopsita cu vopsea pulbere anticoroziva;
- dispunem de o gama variata de carlige si accesorii pentru aceste.

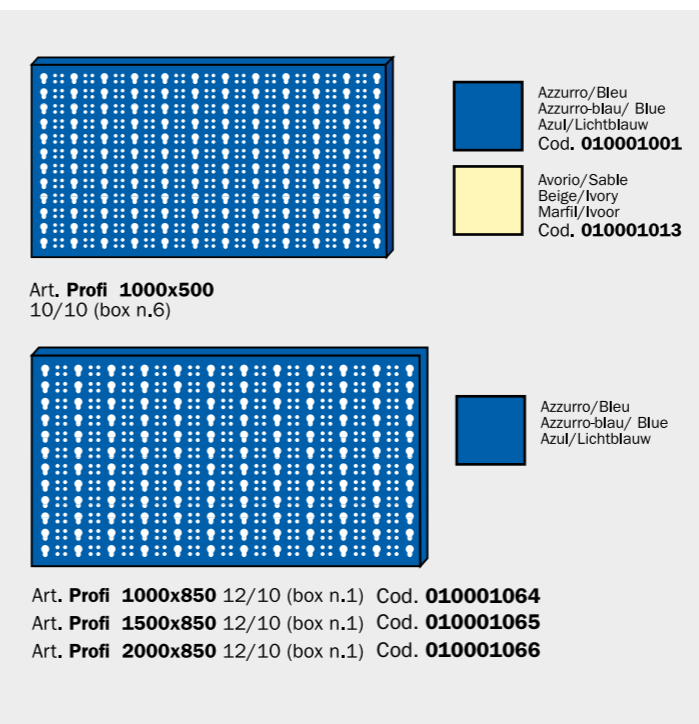



Carrello a tre ripiani smontabile colore rosso RAL 3000 bucciato con maniglione in ABS, tappeto sul ripiano superiore, due ruote fisse e due girevoli.  
Dimensione utile del ripiano 450 x 755 mm con bordo H 40 mm.  
Misure imballo 515x800x180 mm.

Servante à trois plans, démontable, peinte en rouge RAL 3000, grande poignée en ABS, tapis sur le plan supérieur, deux roues fixes et deux pivotantes. Dimension utile du plan 450x755 mm, bord 40 mm h.  
Dimensions emballage: 515x800x180 mm.

3 shelf trolley, easy to dismantle, red RAL 3000 powder-coated with ABS handle, rubber carpet on the upper shelf and nr. 2 stiff + nr. 2 steerable wheels.  
Available surface size 450x755 mm, edge H40 mm.  
Packing dimensions: 515x800x180 mm

Werkstattwagen mit 3 Ablageflächen, abmontierbar, Farbe Rot RAL 3000 Orangenschale. Bearbeitung mit ABS Handgriff. Matte auf der oberen Fläche, zwei befestigte Rollen und zwei schwenkbare. Nutzbare Flächenmaßen 450 x 755 mm mit Kante H 40 mm.  
Verpackungsmaßen: 515 x 800 x 180 mm.

Carro con tres bandejas, desmontable, de color rojo (RAL 3000), con asa ergonómica en ABS, alfombra en la bandeja superior, dos ruedas fijas y dos ruedas giratorias.  
Medida de las bandejas: 450 X 750 mm, con junta de goma H 40 mm.  
Medida de embalaje: 515X800X180 mm.

Carucior cu 3 rafturi demontabil;  
culoare rosu RAL 3000;  
maner in ABS, covoras pe raftul superior;  
2 roti fixe si 2 rotative;  
Dimensiunile utile ale raftului sunt 450x755 mm;  
Greutate portabila 70 kg.

Ø 100



Cod. 010020045

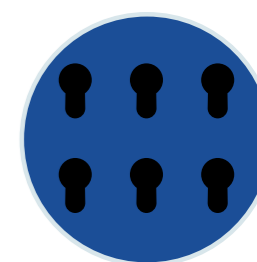
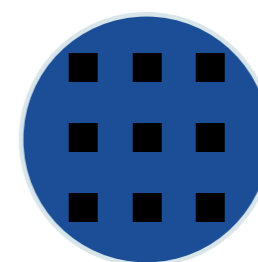

Cassetti accessoriati con sei divisori  
Maniglia autobloccante su ogni cassetto  
Chiusura centralizzata con chiave  
Accessori da acquistare a parte visibili in questa pagina

Tiroirs équipés de 6 séparateurs  
Poignée autoblocante sur chaque tiroir  
Fermeture centralisée à clé  
Accessoires en option illustrés sur cette page

Drawers equipped with 6 partitions  
Self-locking handle on each drawer  
Centralised key-lock shutting  
Optional accessories as shown in this page

Schubladen mit 6 Schubladenteiler versehen.  
Automatische Handgriffblockierung jeder Schublade.  
Zentralverriegelung mit Schlüssel  
Das auf der Abbildung zu sehende Zubehör kann man zusätzlich kaufen

Cajones equipados con seis divisorios  
Manija con bloqueo automático en cada cajón  
Cierre centralizado con llave  
Accesorios para comprar separados que se pueden ver en esta página

6 sertare pe glisiere cu extractie totala pe rulmenti sferici + 6 divizori metalici;  
maner autoblocant pe fiecare sertar pentru deschiderea involuntara;  
inchirire centralizata cu cheie;  
Construit din otel de calitate superioara, cu grosimea de 1.5 mm partea superioara si inferioara si 0.9 mm peretii laterali;  
4 roti din cauciuc plin negru; doua fixe pe ax, doua pivotante, din care una cu sistem de franare.



Carlin S2

Cod. 010020404

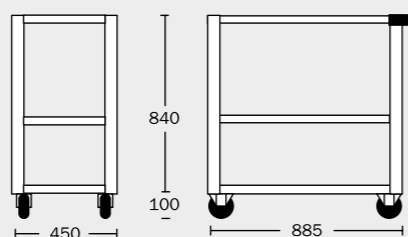

kg 17

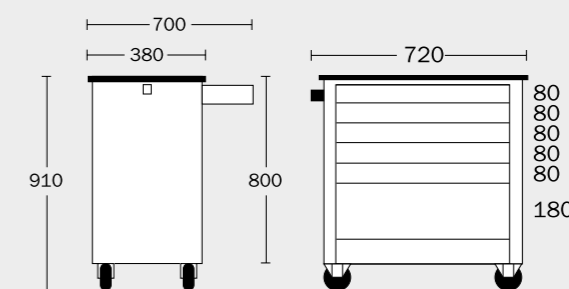

Cod. 010020366

150 kg.

20 kg.

42 kg.

400x680x810 h



Doppia guida telescopica  
Glissières télescopiques double  
Doppelteleskop-Führungsschienen  
Set glisiera telescopic  
Doble guía telescópica  
Set glisiera cu extractie



Cod. **010020045**



Cassetti accessoriati con sei divisori  
Maniglia autobloccante su ogni cassetto  
Chiusura centralizzata con chiave  
Accessori da acquistare a parte visibili in questa pagina

Tiroirs équipés de 6 séparateurs  
Poignée autoblocante sur chaque tiroir  
Fermeture centralisée à clé  
Accessoires en option illustrés sur cette page

Drawers equipped with 6 partitions  
Self-locking handle on each drawer  
Centralised key-lock shutting  
Optional accessories as shown in this page

Schubladen mit 6 Schubladenteiler versehen.  
Automatische Handgriffblockierung jeder Schublade.  
Zentralverriegelung mit Schlüssel  
Das auf der Abbildung zu sehende  
Zubehör kann man zusätzlich kaufen

Cajones equipados con seis divisorios  
Manija con bloqueo automático en cada cajón  
Cierre centralizado con llave  
Accesorios para comprar separados que se pueden ver en esta página

6 sertare pe glisiera cu extractie totala pe rulmenti sferici + 6 divizori metalici;  
maner autoblocant pe fiecare sertar pentru deschiderea involuntara;  
inchirire centralizata cu cheie;  
Construit din oțel de calitate superioara, cu grosimea de 1.5 mm partea superioara si inferioara si 0.9 mm peretii laterali;  
4 roti din cauciuc plin negru; doua fixe pe ax, doua pivotante, din care una cu sistem de franare.

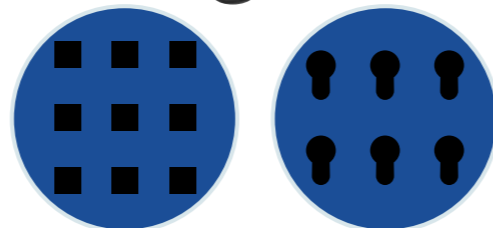

6 cassetti da 80  
1 cassetto da 140

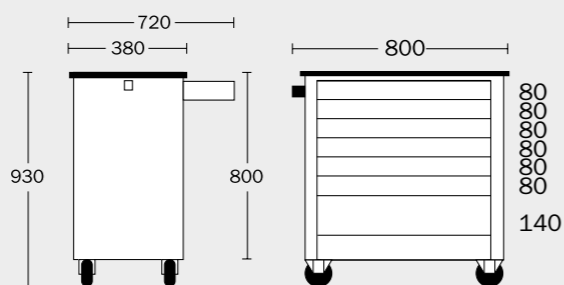

Cod. **010020382**

- 200 kg.
- 20 kg.
- 60 kg.
- 400x730x900 h



**40 mm**

Piana in faggio Buchen Holzplatte  
Plateau hêtre Plancha de haya  
Beech-wooden board Blat de fag

Art. **LFE 1000** - Kg 20,00 - Cod. **010021050**

Art. **LFE 1500** - Kg 30,00 - Cod. **010021051**

Art. **LFE 2000** - Kg 40,00 - Cod. **010021052**



**45 mm**

Piana in faggio Rubber covered beech-  
con ricopertura in gomma wooden board  
Plateau hêtre en caou- Plancha de haya recubierta  
tchouc con goma  
Buchen Holzplatte mit Blat de fag cu cauciuc  
Gummimatte

Art. **LFE 1000/G** - Kg 24,00 - Cod. **010021186**

Art. **LFE 1500/G** - Kg 36,00 - Cod. **010021187**

Art. **LFE 2000/G** - Kg 48,00 - Cod. **010021188**



**30 mm**

Piana in legno multistrati Mehrschicht-Holzplatte  
Plateau bois multicouche Plancha contrachapada de madera  
Wooden multilayer board Blat din lemn multistrat

Art. **LE 1000** - Kg 12,00 - Cod. **010021008**

Art. **LE 1500** - Kg 18,00 - Cod. **010021009**

Art. **LE 2000** - Kg 21,00 - Cod. **010021010**



**35 mm**

Piana in legno multistrati Mehrschicht-Holzplatte mit Gummi-  
con ricopertura in gomma matte  
Plateau bois multicouche Plancha contrachapada de madera  
en caoutchouc recubierta con goma  
Rubber covered wooden Blat de lemn multistrat cu cauciuc  
multilayer board

Art. **LE 1000/G** - Kg 16,00 - Cod. **010021180**

Art. **LE 1500/G** - Kg 22,00 - Cod. **010021181**

Art. **LE 2000/G** - Kg 29,00 - Cod. **010021182**



**40 mm - 30/10**

Piana in ferro zincato Verzinkte Stahlblech-Platte  
Plateau fer zingue Plancha de hierro cincado  
Zinc-plated iron board Blat din fier zincat

Art. **FZ 1000** - Kg 28,00 - Cod. **010021014**

Art. **FZ 1500** - Kg 41,00 - Cod. **010021015**

Art. **FZ 2000** - Kg 54,00 - Cod. **010021016**



**45 mm - 30/10**

Piana in ferro zincato con Rubber covered zinc-plated  
ricopertura in gomma iron board  
Plateau fer zingue en Plancha de hierro cincado  
caoutchouc recubierta con goma  
Verzinkte Stahlblech-Plat- Blat de fier zincat cu cauciuc  
te mit Gummimatte

Art. **FZ 1000/G** - Kg 32,00 - Cod. **010021195**

Art. **FZ 1500/G** - Kg 47,00 - Cod. **010021196**

Art. **FZ 2000/G** - Kg 62,00 - Cod. **010021197**

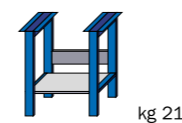
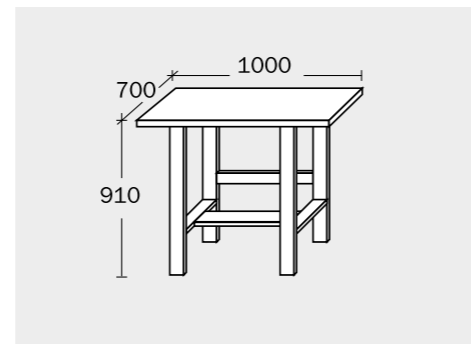

kg 21

**Art. SM 1000**  
Cod. **010021003**

Struttura composta da: 2 gambe banco + 4 traversini da 1000 mm  
Structure composée par: 2 piéds + 4 traversines 1000 mm  
Structure composed of: 2 bench legs + 4 sleepers 1000 mm

Grundgestell zusammengesetzt aus: 2 Fußgestellen + 4 Traversen zu 1000 mm  
Estructura composta: 2 patas + 4 traversanos de 1000 mm  
Structura pentru banc de 1000mm compusa din doua picioare+4 traverse din fier zincat de 1000



kg 7

**Art. Work 1**  
Cod. **010021006**  
**600x510x145H**

Cassetto con guide scorrevoli e serratura  
Tiroir avec coulisses et serrure  
Drawer with ball bearing slides and lock

Schublade mit Kugelgelagerten Führungsschienen und Zylinderschloß.  
Cajon con estructura metálica, guías correderas y cerradura  
Casetiera cu un sertar cu extractie pe glisiere si inchidere cu cheie



kg 37

**Art. Work 3**  
Cod. **010021073**  
**420x615x565H**

Cassetiera composta da 4 cassetti totalmente estraibili con divisori e serratura.  
Meuble à tiroirs composé par 4 tiroirs totalement extractibles avec séparateurs et serrure centralisée.  
Drawers-chest composed of 4 completely extractable drawers endowed with partitions and centralised lock

Schubladenschrank mit 4 Schubladen mit Vollauszug, Zentralverriegelung und mit Trennwinkel ausgestattet.  
Cajonera con estructura metálica, 4 cajones totalmente extraíbles y con separadores metálicos y cerradura centralizada  
Casetiera cu 4 sertare cu extractie totala cu divizori si inchirere centralizata



kg 55

**Art. Work 4**  
Cod. **010021081**  
**720x615x565H**

Cassetiera composta da 4 cassetti totalmente estraibili con divisori e serratura.  
Meuble à tiroirs composé par 4 tiroirs totalement extractibles avec séparateurs et serrure centralisée.  
Drawers-chest composed of 4 completely extractable drawers endowed with partitions and centralised lock

Schubladenschrank mit 4 Schubladen mit Vollauszug, Zentralverriegelung und mit Trennwinkel ausgestattet.  
Cajonera con estructura metálica, 4 cajones totalmente extraíbles y con separadores metálicos y cerradura centralizada  
Casetiera cu 4 sertare cu extractie totala cu divizori si inchirere centralizata

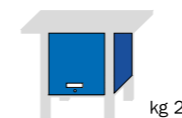

kg 27,5

**Art. Work 4 Free**  
Cod. **010021082**  
**720x615x565H**

Fornito già montato, ha un piano intermedio di 350 mm. È chiuso con una porta basculante dotata di serratura con chiave.  
Livré déjà monté, il est doté d'une étagère intérieure de 350 mm de profondeur. Fermeture par une porte basculante à clé.  
Delivered already assembled, it has an intermediate plane of 350 mm dept. Closing by a balancing door endowed with key-lock.

Schubladenschrank Work 4 free. Innen befindet sich eine Ablagefläche und wird geschlossen durch eine Klappentuer, welche eine Zylinderschlossverriegelung hat.  
Enstructura en chapa interamente soldada y con estante central de 350 mm de profundidad. Se cierra por medio de una puerta basculante y su cerradura con llave.  
Dulap cu o traversa metalica interna pentru scule; usa basculata cu inchidere cu cheie.

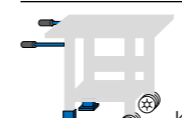

kg 4

**Art. 1000-1500/S**  
Cod. **010021025**

Kit carrellato con ruote in nylon 2 regolatori d'altezza e maniglia  
Set de roulettes avec roues en nylon, 2 régulateurs d'hauteur et poignée  
Kit composed of nylon wheels, 2 height regulators and handle

Rollenset mit Nylonrollen, höhenverstellbaren Füßen und Handgriff.  
Kit ruedas en nylon, 2 reguladores de altura y asa.  
Kit cu manere si roti pentru bancul de 1000/1500; roti din plastic special si doua picioruse de inaltare pentru banc; greutate portanta a bancului pana la 700 kg.



kg 2,4

**Art. 1000-1500/K**  
Cod. **010021022**

Kit 4 regolatori d'altezza  
Set régulateurs d'hauteur  
Kit of 4 height regulators.

Höhenregler-Set mit 4 verstellbaren Füßen.  
Kit 4 reguladores de altura.  
Kit de 4 picioruse de reglare a inaltimii bancului

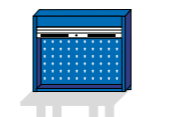

kg 29

**Art. Pratico 1000**  
Cod. **010021041**  
**1000x200x1000H**

Armadio in lamiera dotato di serranda con serratura, pannello forato per fissaggio portautensili e Kit portautensili.  
Armoire en tôle doté de rideau avec serrure. Panneau foré pour le fixation des porte-outils et set porte-outils.  
Plate cabinet complete of shutter with lock, perforated panel to fix tools-stands and tools-stand kit

Werkzeugschrank aus Stahlblech mit verschließbarer Jalousie. Lochrückwand zur Werkzeuganbringung komplett mit Werkzeughalter-Set zur Ausstattung der Lochwand.  
Armario de chapa con persiana y cerradura, panel cuelgaherramientas y kit portaherramientas  
Dulap metalic cu jaluzea din aluminiu cu inchidere cu cheie; Panou perforat pentru fixarea sculelor; kit de 40 de carlige din plastic diverse+un pahar din plastic B08+un suport pentru burghie B12.

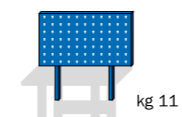

kg 11

**Art. 1000/2SP + Kit acc. 1000**  
Cod. **010001058**  
**1000x850**

Pannello Profi con 2 supporti + mensola da 1000 mm, 40 ganci assortiti, 1 bicchierino B08 e 1 portapunte B12  
Panneau profi 1000x850 avec deux supports panneau + console de 1000 mm, 40 crochets assortis, 1 art. B08 et 1 porte-pointes B12  
Profi panel 1000x850 with 2 panel brackets + 1 console 1000, 40 assorted hooks, 1 art. B08 and 1B12 drill-stand

Werkzeugwand Profi 1000x850 mit 2 Halterungen + Konsole zu 1000, 40 sortierten Kunststoffhaken, 1 Profibehälter B08 und 1 Bohrerhalter B12  
Pannel PROFi 1000x850 con 2 soportes panel + estante de 1000 mm., 40 ganchos variados, 1 vasito B08 y 1 porta-puntas de taladro.  
Panou perforat de 1000/850mm cu 2 suporturi pentru fixare pe banc-o tavita de 1000; kit de 40 de carlige din plastic diverse+un pahar din plastic B08+un suport pentru burghie B12.

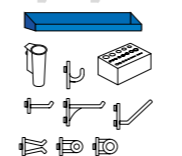



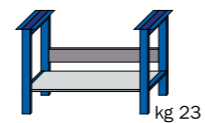
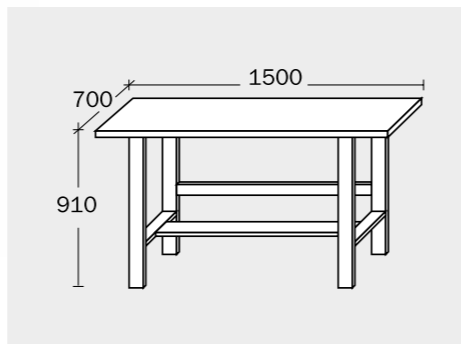

kg 23

**Art. SM 1500**  
**Cod. 010021004**

Struttura composta da: 2 gambe banco + 4 traversini da 1500 mm  
Structure composée par: 2 piéds + 4 traversines 1500 mm  
Structure composed of: 2 bench legs + 4 sleepers 1500 mm

Grundgestell zusammengesetzt aus: 2 Fußgestellen + 4 Traversen zu 1500 mm  
Estructura composta: 2 patas + 4 traversanos de 1500 mm  
Structura pentru banc compusa din doua picioare + 4 traverse din fier zincat de 1500

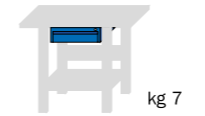

kg 7

**Art. Work 1**  
**Cod. 010021006**  
**600x510x145H**

Cassetto con guide scorrevoli e serratura  
Tiroir avec coulisses et serrure  
Drawer with ball bearing slides and lock

Schublade mit kugelgelagerten Führungsschienen und Zylinderschloß.  
Cajon con estructura metálica, guías correderas y cerradura  
Casetiera cu un sertar cu extractie pe glisiere si inchidere cu cheie



kg 37

**Art. Work 3**  
**Cod. 010021073**  
**420x615x565H**

Cassettiera composta da 4 cassetti totalmente estraibili con divisori e serratura.  
Meuble à tiroirs composé par 4 tiroirs totalement extractibles avec séparateurs et serrure centralisée.  
Drawers-chest composed of 4 completely extractable drawers endowed with partitions and centralised lock

Schubladenschrank mit 4 Schubladen mit Vollauszug, Zentralverriegelung und mit Trennwinkel ausgestattet.  
Cajonera con estructura metálica, 4 cajones totalmente extraíbles y con separadores metálicos y cerradura centralizada  
Casetiera cu 4 sertare cu extractie totala cu divizori si inchirere centralizata



kg 55

**Art. Work 4**  
**Cod. 010021081**  
**720x615x565H**

Cassettiera composta da 4 cassetti totalmente estraibili con divisori e serratura.  
Meuble à tiroirs composé par 4 tiroirs totalement extractibles avec séparateurs et serrure centralisée.  
Drawers-chest composed of 4 completely extractable drawers endowed with partitions and centralised lock

Schubladenschrank mit 4 Schubladen mit Vollauszug, Zentralverriegelung und mit Trennwinkel ausgestattet.  
Cajonera con estructura metálica, 4 cajones totalmente extraíbles y con separadores metálicos y cerradura centralizada  
Casetiera cu 4 sertare cu extractie totala cu divizori si inchirere centralizata

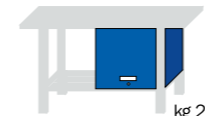

kg 27,5

**Art. Work 4 Free**  
**Cod. 010021082**  
**720x615x565H**

Fornito già montato, ha un piano intermedio di 350 mm. E' chiuso con una porta basculante dotata di serratura con chiave.  
Livré déjà monté, il est doté d'une étagère intérieure de 350 mm de profondeur. Fermeture par une porte basculante à clé.  
Delivered already assembled, it has an intermediate plane of 350 mm dept. Closing by a balancing door endowed with key-lock.

Schubladenschrank Work 4 free.  
Innen befindet sich eine Ablageflaeche und wird geschlossen durch eine Klappentuer, welche eine Zylinderschlossverriegelung hat.  
Enstructura en chapa interamente soldada y con estante central de 350 mm de profundidad. Se cierra por medio de una puerta basculante y su cerradura con llave.  
Dulap cu o travesa metalica interna pentru scule; usa basculata cu inchidere cu cheie.



kg 4

**Art. 1000-1500/S**  
**Cod. 010021025**

Kit carrellato con ruote in nylon  
2 regolatori d'altezza e maniglia  
Set de roulettes avec roues en nylon, 2 régulateurs d'hauteur et poignée  
Kit composed of nylon wheels, 2 height regulators and handle

Rollenset mit Nylonrollen, höhenverstellbaren Füßen und Handgriff.  
Kit ruedas en nylon, 2 reguladores de altura y asa.  
Kit cu manere si roti pentru bancul de 1000/1500; roti din plastic special si doua picioruse de inaltare pentru banc;



kg 2,4

**Art. 1000-1500/K**  
**Cod. 010021022**

Kit 4 regolatori d'altezza  
Set régulateurs d'hauteur  
Kit of 4 height regulators.

Höhenregler-Set mit 4 verstellbaren Füßen.  
Kit 4 reguladores de altura.  
Kit de 4 picioruse de reglare a inaltimii bancului

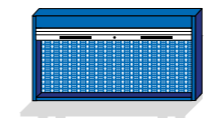

kg 41

**Art. Pratico 1500**  
**Cod. 010021043**  
**1500x200x1000H**

Armadio in lamiera dotato di serranda con serratura, pannello forato per fissaggio portautensili e Kit portautensili.  
Armoire en tôle doté de rideau avec serrure. Panneau foré pour le fixage des porte-outils et set porte-outils.  
Plate cabinet complete of shutter with lock, perforated panel to fix tools-stands and tools-stand kit

Werkzeugschrank aus Stahlblech mit verschließbarer Jalousie. Lochrückwand zur Werkzeuganbringung komplett mit Werkzeughalter-Set zur Ausstattung der Lochwand.  
Armario de chapa con persiana y cerradura, panel cuelgaherramientas y kit portaherramientas  
Dulap metalic cu jaluzea din aluminiu cu inchidere cu cheie; Panou perforat pentru fixarea sculelor; kit de 40 de carlige din plastic diverse+un pahar din plastic B08+un suport pentru burghie B12.

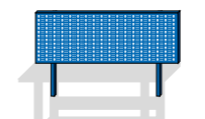

kg 13

**Art. 1500/2SP + Kit acc. 1500**  
**Cod. 010001059**  
**1500x850**

Pannello Profi con 2 supporti + mensola da 1500 mm, 60 ganci assortiti, 1 bicchierino B08 e 1 portapunte B12  
Panneau profi avec deux supports panneau + console de 1500 mm, 60 crochets assortis, 1 art. B08 et 1 porte-pointes B12  
Werkzeugwand Profi mit 2 Halterungen + Konsole zu 1500, 60 sortierten Kunststoffhaken, 1 Profibehälter B08 und 1 Bohrerhalter B12

Profi panel with 2 panel brackets + 1 console 1500, 60 assorted hooks, 1 art. B08 and 1B12 drill-stand  
Pannel PROFI con 2 soportes panel + estante de 1500 mm., 60 ganchos variados, 1 vasito B08 y 1 portapuntas de taladro.  
Panou perforat cu 2 suporturi pentru fixare pe banc+o tavita de 1500; kit de 60 de carlige din plastic diverse+un pahar din plastic B08+un suport pentru burghie B12.

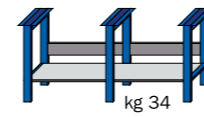
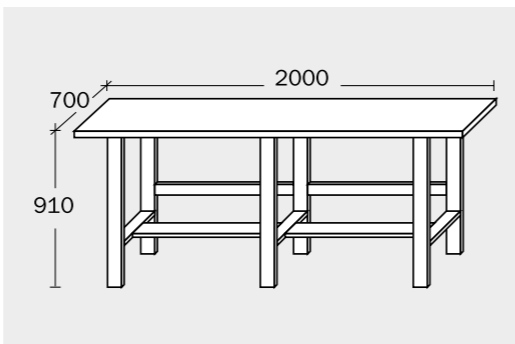

kg 34

**Art. SM 2000**  
Cod. **010021005**

Struttura composta da: 3 gambe banco + 8 traversini da 1000 mm  
Structure composée par: 3 piéds + 8 traversines 1000 mm  
Structure composed of: 3 bench legs + 8 sleepers 1000 mm

Grundgestell zusammengesetzt aus: 3 Fußgestellen + 8 Traversen zu 1000 mm  
Estructura composta: 2 patas + 4 traversanos de 1000 mm  
Structura pentru banc de 2000mm compusa din trei picioare+8 traverse din fier zincat de 1000mm

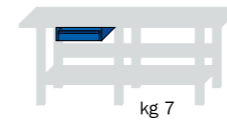

kg 7

**Art. Work 1**  
Cod. **010021006**  
**600x510x145H**

Cassetto con guide scorrevoli e serratura  
Tiroir avec coulisses et serrure  
Drawer with ball bearing slides and lock

Schublade mit kugelgelagerten Führungsschienen und Zylinderschloß.  
Cajon con estructura metálica, guías correderas y cerradura  
Casetiera cu un sertar cu extractie pe glisiere si inchidere cu cheie



kg 37

**Art. Work 3**  
Cod. **010021073**  
**420x615x565H**

Cassetiera composta da 4 cassetti totalmente estraibili con divisori e serratura.  
Meuble à tiroirs composé par 4 tiroirs totalement extractibles avec séparateurs et serrure centralisée.  
Drawers-chest composed of 4 completely extractable drawers endowed with partitions and centralised lock

Schubladenschrank mit 4 Schubladen mit Vollauszug, Zentralverriegelung und mit Trennwinkel ausgestattet.  
Cajonera con estructura metálica, 4 cajones totalmente extraíbles y con separadores metálicos y cerradura centralizada  
Casetiera cu 4 sertare cu extractie totala cu divisori si inchirere centralizata

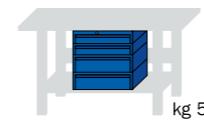

kg 55

**Art. Work 4**  
Cod. **010021081**  
**720x615x565H**

Cassetiera composta da 4 cassetti totalmente estraibili con divisori e serratura.  
Meuble à tiroirs composé par 4 tiroirs totalement extractibles avec séparateurs et serrure centralisée.  
Drawers-chest composed of 4 completely extractable drawers endowed with partitions and centralised lock

Schubladenschrank mit 4 Schubladen mit Vollauszug, Zentralverriegelung und mit Trennwinkel ausgestattet.  
Cajonera con estructura metálica, 4 cajones totalmente extraíbles y con separadores metálicos y cerradura centralizada  
Casetiera cu 4 sertare cu extractie totala cu divisori si inchirere centralizata

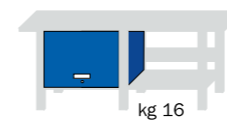

kg 16

**Art. Work 4 Free**  
Cod. **010021082**  
**720x615x565H**

Fornito già montato, ha un piano intermedio di 350 mm. E' chiuso con una porta basculante dotata di serratura con chiave.  
Livré déjà monté, il est doté d'une étagère intérieure de 350 mm de profondeur. Fermeture par une porte basculante à clé.  
Delivered already assembled, it has an intermediate plane of 350 mm depth. Closing by a balancing door endowed with key-lock.

Schubladenschrank Work 4 free.  
Innen befindet sich eine Ablagefläche und wird geschlossen durch eine Klappentuer, welche eine Zylinderschlossverriegelung hat.  
Enstructura en chapa interamente soldada y con estante central de 350 mm de profundidad. Se cierra por medio de una puerta basculante y su cerradura con llave.

Dulap cu o traversa metalica interna pentru scule; usa basculata cu inchidere cu cheie.



Kg 3,6

**Art. 2000/K**  
Cod. **010021023**

Kit 6 regolatori d'altezza  
Set régulateurs d'hauteur  
Kit of 6 height regulators.

Höhenregler-Set mit 4 verstellbaren Füßen.  
Kit 6 reguladores de altura.  
Kit de 6 picioruse antivibrante pentru banc din cauciuc

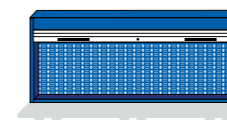

kg 54

**Art. Pratico 2000**  
Cod. **010021045**  
**2000x200x1000H**

Armadio in lamiera dotato di serranda con serratura, pannello forato per fissaggio portautensili e Kit portautensili.  
Armoire en tôle doté de rideau avec serrure. Panneau foré pour le fixation des porte-outils et set porte-outils.  
Plate cabinet complete of shutter with lock, perforated panel to fix tools-stands and tools-stand kit

Werkzeugschrank aus Stahlblech mit verschließbarer Jalousie. Lochrückwand zur Werkzeuganbringung komplett mit Werkzeughalter-Set zur Ausstattung der Lochwand.  
Armario de chapa con persiana y cerradura, panel cuelgaherramientas y kit portaherramientas  
Dulap metalic cu jaluzea din aluminiu cu inchidere cu cheie; Panou perforat pentru fixarea sculelor; kit de 80 de carlige din plastic diverse+un pahar din plastic B08+doua suporturi pentru burghie B12.

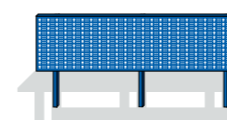

kg 17

**Art. 2000/3SP + 2Kit acc. 1000**  
Cod. **010001060**  
**2000x850**

Pannello Profi con 3 supporti + mensola da 2000 mm, 80 ganci assortiti, 1 bicchierino B08 e 1 portapunte B12  
Panneau profi 2000x850 avec deux supports panneau + console de 2000 mm, 80 crochets assortis, 1 art. B08 et 1 porte-pointes B12  
Profi panel 2000x850 with 3 panel brackets + 1 console 2000, 80 assorted hooks, 1 art. B08 and 1B12 drill-stand

Werkzeugwand Profi 2000x850 mit 3 Halterungen + Konsole zu 2000, 80 sortierten Kunststoffhaken, 1 Profibehälter B08 und 1 Bohrerhalter B12  
Pannel PROFI 2000x850 con 3 soportes panel + estante de 2000 mm., 80 ganchos variados, 1 vasito B08 y 1 porta-puntas de taladro.  
Panou perforat de 2000/850mm cu 3 suporturi pentru fixare pe banc+o tavita de 2000; kit de 80 de carlige din plastic diverse+un pahar din plastic B08+un suport pentru burghie B12.

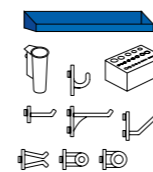



# BM industrie